

Bed Concept

Design by Bo Concept

Samvejledning - Assembly Instructions - Montageanleitung - Instructions d'assemblage - Instrucciones de montaje

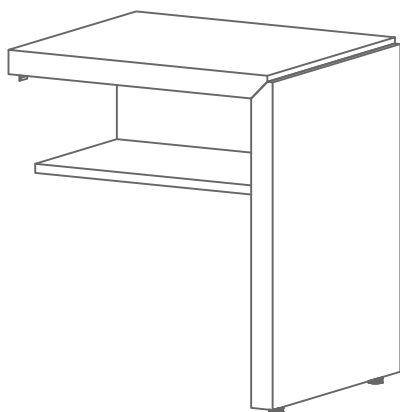

1010

44,8x39,4x33 cm

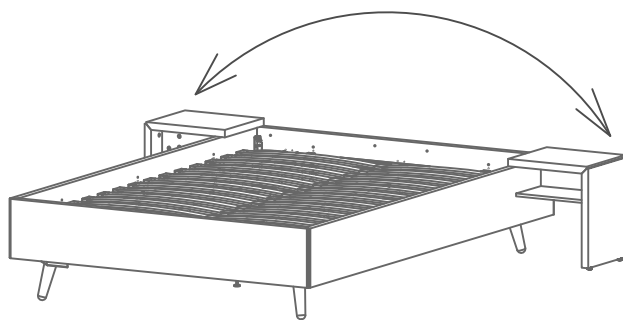

004323

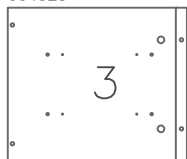

004325

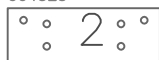

004322



004324

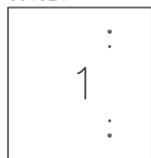

Beslag - Beschläge - Fittings - Set de montage - Acessórios

Fittingbox: 930000868



A X 6
979900041
6x30mm



B X 5
970001699
3x7,5mm



C X 9
970001697



D X 2
970001008

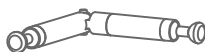

E X 2
970001318



F X 2
970001715
M6x8









G X 2
970001716
M6



H X 2
970001329
ash gray
970001383
White

Værktøj -
Werkzeuge -
Tools - Outils

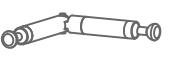

- 
A X 6
6x30mm
- 
B X 5
3x7,5mm
- 
C X 9
- 
D X 2
- 
E X 2
- 
F X 2
M6x8
- 
G X 2
M6

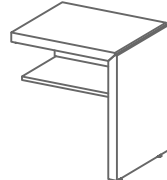
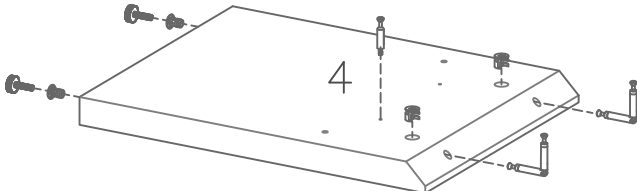
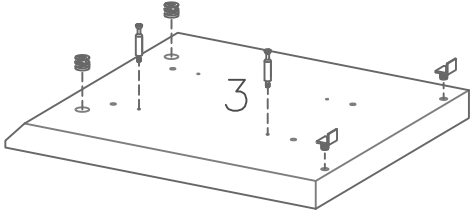
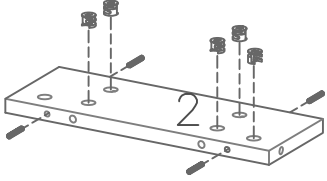
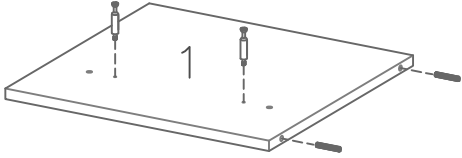

example

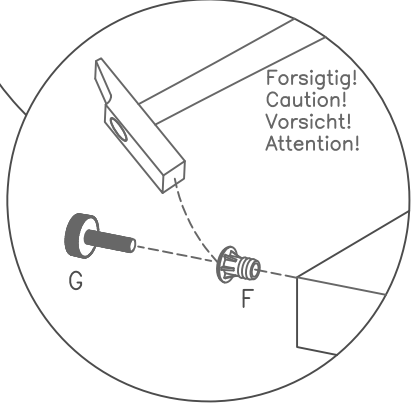
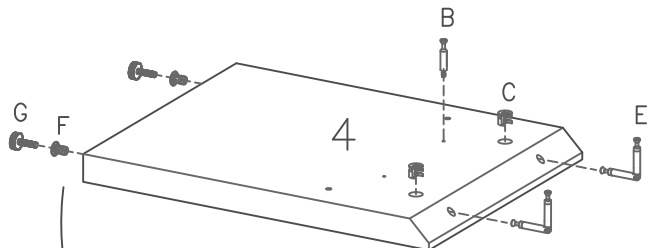
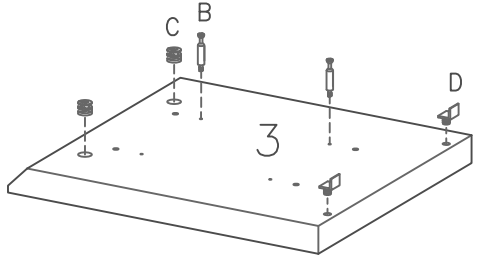
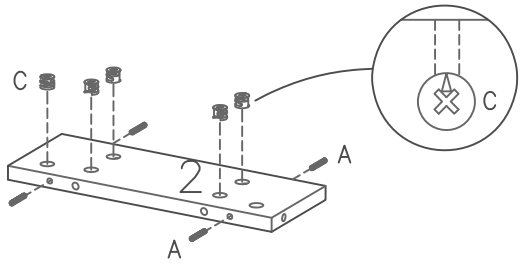
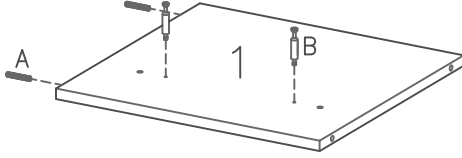

FIG. 2



example

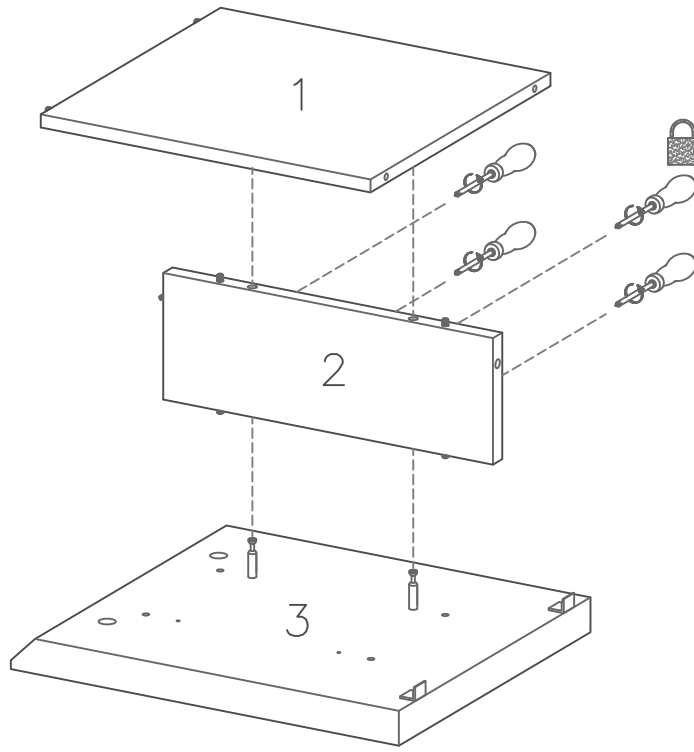
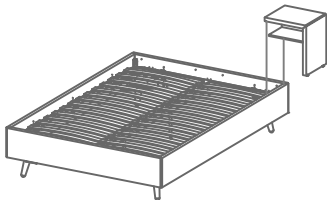
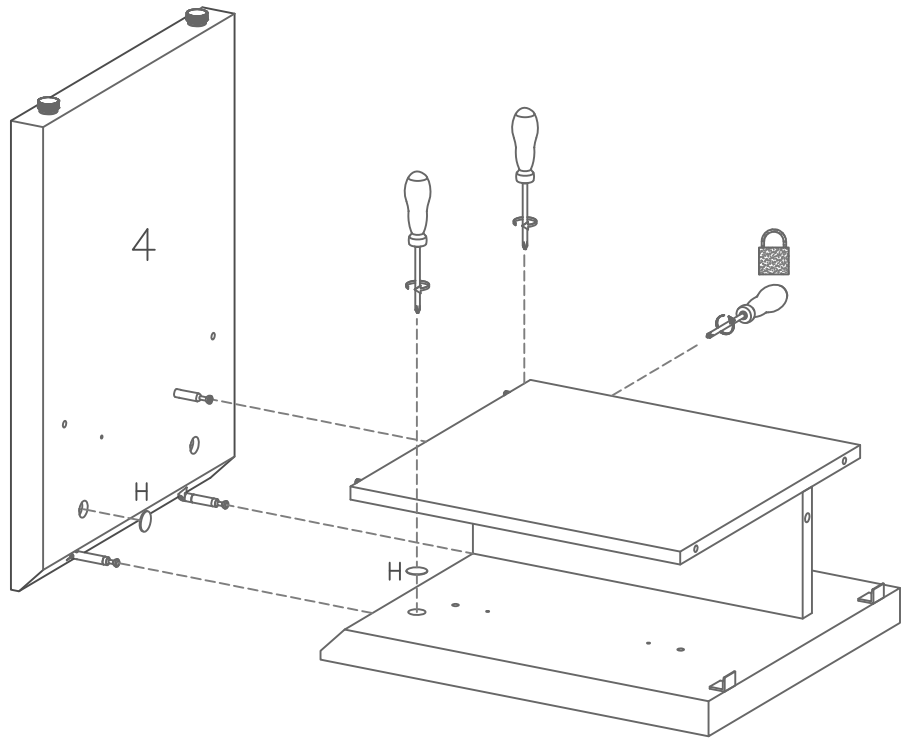

FIG. 3



example

H X 2



DK Ved reklamation oplyses følgende:
D Im Reklamationsfall, bitte folgendes erläutern:
US In case of claims, please state the following:
F En cas de reclamation, veuillez indiquer:
NL Bij service volgene mededelen
E En caso de reclamacion, indicar lo siguiente:
P No caso de reclamação, por favor indique o seguinte:
JP お気づきの点等ございましたら、以下の点をお知らせください。

Example!

